

SPECIFICATION
For
SWITCHING POWER SUPPLY

M/N: MPI-G403

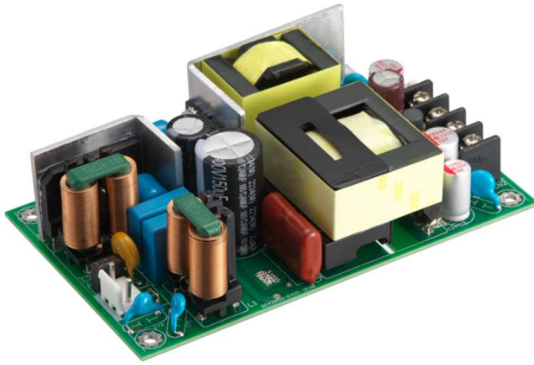

FEATURES

- ✓ 400W with fan cooling, 250W convection-cooled of single output power supply.
- ✓ Compact size 3 x 5 inch and low profile.
- ✓ High efficiency up to 92%.
- ✓ Design to meet ITE safety standard IEC 62368-1, UL 62368-1 CE LVD.
- ✓ Design to meet EN 60335-1.
- ✓ Meets EMI CISPR/FCC class B.
- ✓ PFC meet EN 61000-3-2 Class D and EN 61000-3-3.

Models & Ratings

Model Number	Wattage (Convection-cooled / Fan cooling)	Output Voltage	Min. Current	Convection cooling Rated Current	Fan cooling Rated Current (40CFM)
MPI-G403	250 W / 400 W	+12V	0 A	20.83 A	33.33 A

Input

Characteristic	Minimum	Typical	Maximum	Units	Notes & Conditions
Input Voltage	80	115 / 230	264	VAC	Continuous input range.
Input Frequency	47	50 / 60	63	Hz	AC input.
Input Current			5	A	AC Input Voltage (100VAC, 400W).
Inrush Current			30 / 60	A	Nominal AC Input Voltage (115VAC/230VAC), one cycle at 25°C cold start.
Switching Frequency		70		KHZ	Frequency conversion
Input Protection	One non-user serviceable internally located AC input line fuse. Fuse : 6.3A / 250VAC * 1pcs				

Output

Characteristic	Minimum	Typical	Maximum	Units	Notes & Conditions
Output Voltage		+12 V		DC	
Fan Output Voltage	8V	12V	14V		When Fan starts up, the output current must be 2.5A at least for 12V output.
Fan Output Current			0.2A		
Efficiency		92		%	At input 230VAC, 250W load, 1hr above. warm up.
Initial Set Accuracy		±1.0 ^(v1)		%	Initial setting accuracy is adjusted at input 115VAC and output at 60% of 400W load.
Start Up Delay		1.5		Sec	Time required for initial output voltage stabilization.
Hold Up Time		24		mS	Nominal AC Input Voltage, 250W load.
		14		mS	Nominal AC Input Voltage, 400W load.
Line Regulation		±1.0		%	Less than ±1% at 400W load with ±10% changing in input voltage 115VAC.
Load Regulation		±1.0		%	Measured from 60% to 100% of 400W load and from 60% to 20% of 400W load.
Ripple & Noise		120		mV	400W load by a 20MHz bandwidth limited oscilloscope and the each output is connected with a 10µF Electrolytic Capacitor and a 0.1µF Ceramic Capacitor.
Earth leakage Current			1	mA(rms)	At input 264VAC, 63Hz, 400W load.
No-load power consumption		0.5		W	Nominal AC Input Voltage (115VAC/230VAC).
Overvoltage Protection	For some reason the power supply fails to control itself, the build-in over voltage protection circuit will latch off the outputs to prevent damaging external circuits, the trigger point is around 110%~140% of output voltage.				
OCV and Short Circuit Protection	Fully protected against output over current and short circuit. Automatic recovery upon of over current condition.				
Characteristic	Minimum	Rated load (250W)	Rated load (400W)	Units	Notes & Conditions
Output Current	0	20.83	33.33	A	

Note: 1. 250W is Convection cooling.
2. 400W is Fan cooling..

Environmental

Characteristic	Minimum	Typical	Maximum	Units	Notes & Conditions
Operating Temperature	-20		+80	°C	See the following performance curves for the detail.
Storage Temperature	-40		+85	°C	
Relative Humidity	5		95	%RH	Non-condensing.
Cooling		40		CFM	400W load.
Operating		5000		m	

Derating curve

1. Output Power (W) versus Ambient Temp.(°C) Curve

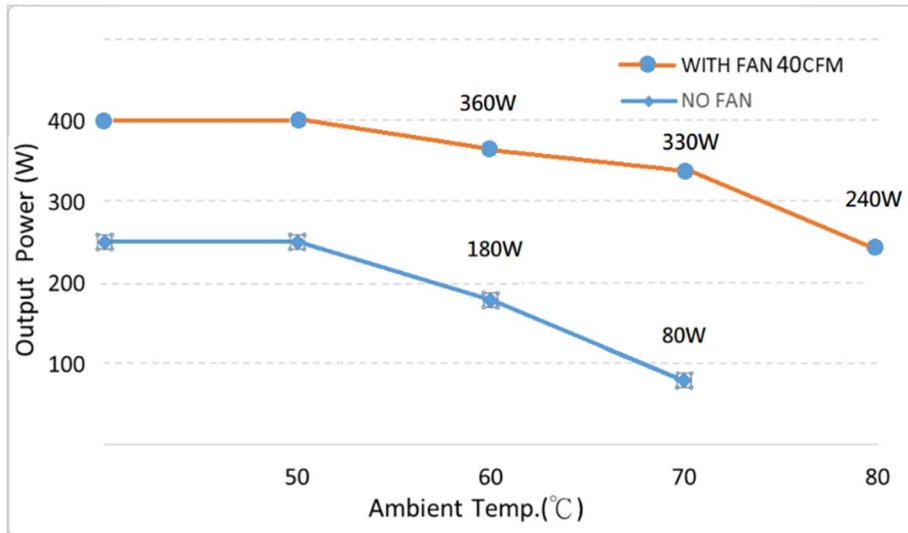

2. Output Power (W) versus Input Voltage(VAC) Curve

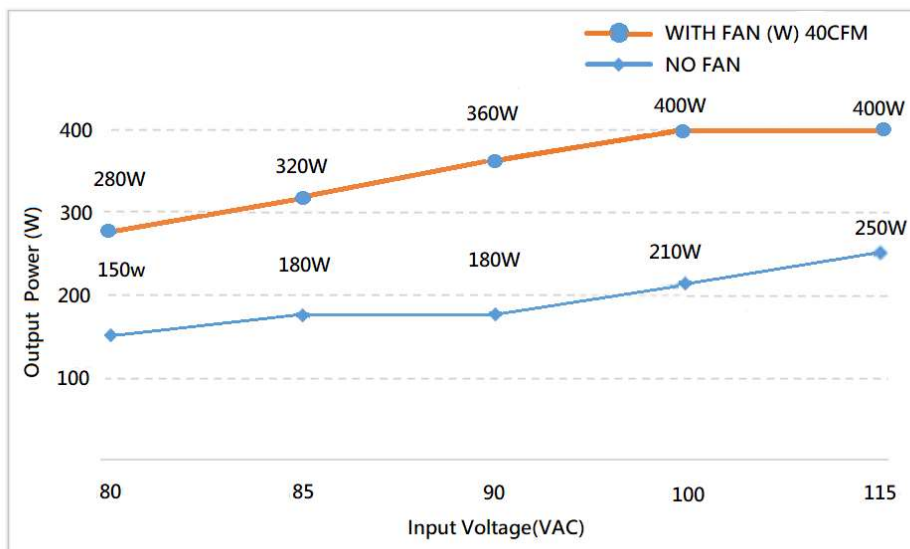

Note: If the operating temp exceeds 50°C, please refer to graph 1 for deration curve and according output proportion.

EMC: Emissions

Phenomenon	Standard	Class	Notes & Conditions
Conducted	EN 55022 / EN 55032 CISPR 22 & FCC Part 15	B	
Radiated	EN 55022 / EN 55032 CISPR 22 & FCC Part 15	B	
Harmonic Current	EN 61000-3-2	D	
Voltage Flicker	EN 61000-3-3	PASS	

EMC: Immunity

Phenomenon	Standard	Criteria	Notes & Conditions
ESD	IEC 61000-4-2	A	±8KV air discharge, ±6KV contact discharge
Radiated	IEC 61000-4-3	A	10V/m
EFT	IEC 61000-4-4	A	±2KV Line & PE
Surges	IEC 61000-4-5	A	L-N:±1KV, L/N-PE:±2KV
Conducted	IEC 61000-4-6	A	10V
Power Magnetic	IEC 61000-4-8	A	10A/m
Dips and Interruptions	IEC 61000-4-11	A A / B A / B B	DIP: >95%, 0.5 cycle DIP: 30%, 25 cycles (Note 2) DIP: 60%, 5 cycles (Note 2) INT: >95%, 250 cycles

Note:

- As a build-in type power supply, the power supply needs to be installed in a suitable enclosure to pass the EMI/EMC tests. The final assembly has to comply with the valid EMI/EMC and safety.
- The dips test result of input 240Vac / 100Vac is criteria A / B.
- The mounting holes should be connected to each other to conform the EMI limit.

Safety

Characteristic	Minimum	Typical	Maximum	Units	Notes & Conditions
Isolation	IP to OP	3000		VAC	
	IP to GND	1800		VAC	
Safety Agency	Safety Standard			Notes & Conditions	
CE(LVD)	EN 62368-1, 2 nd Edition			Pending.	
UL/cUL	UL 62368-1, 2 nd Edition, CSA C22.2 No. 62368-1-14, 2 nd Edition			Designed to meet.	
CE	EN 60335-1, IEC 60335-1, UL 60335-1			Designed to meet. (Note 1)	
CB	IEC 62368-1, 2 nd Edition			Designed to meet.	

Note:

- Applied to Class I stationary devices and system ground wires must meet the grounding test requirements.

Mechanical Details

All dimensions are in Inches [mm] Tolerance ± 0.02 [± 0.5]

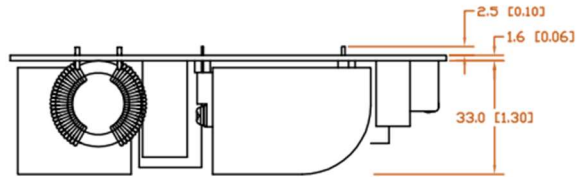

Ac Input Connector CN1	
Mates with MOLEX 09-50-1031(5195-03) OR 09-52-4034(5239-03) OR Equivalent JST: VHR-3N OR Equivalent (Note)	
PIN number	PIN assignment
1	AC in(L)
2	AC in(N)

Note: Exist with model no. suffixed -J,
please see comparison in Model no. coding:

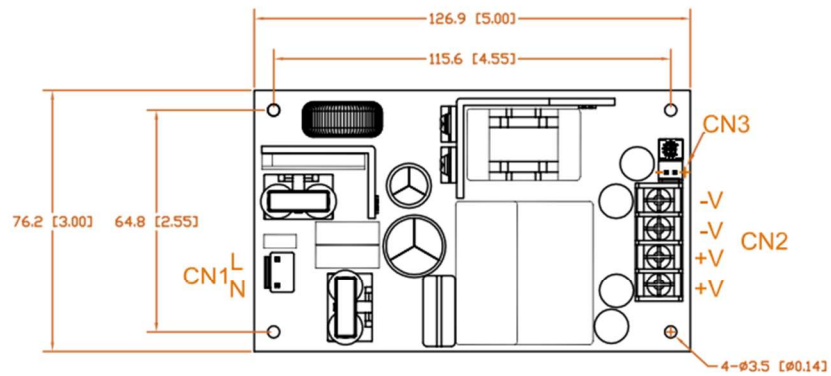

Single Connector CN3	
MOLEX5045-02A or Equivalent	
PIN number	PIN assignment
1	Fan 12V (V Fan)
2	0V

Dc Output Terminal Blocks CN2	
DINKLE DT-35 European type by request	
PIN number	PIN assignment
1	-V
2	-V
3	+V
4	+V

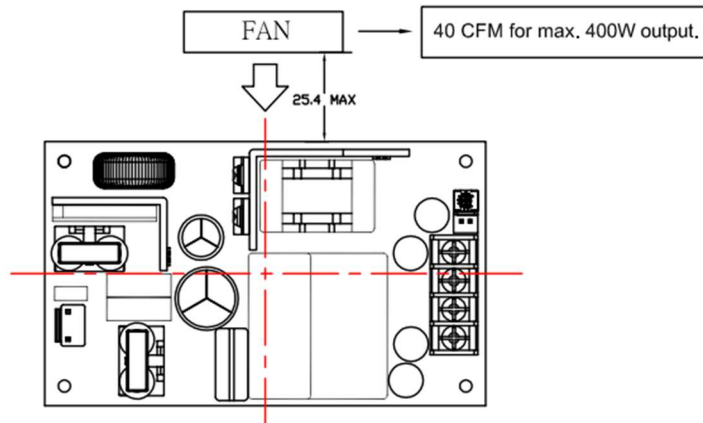

Temperature for component below cannot exceed 130° C. If the temperature exceed 130° C in actual working condition, please apply additional heat conductive foams.

Thermal Considerations

In order to ensure safe operation of the PSU in the end-use equipment, the temperature of the components listed in the table below must not be exceeded.

Temperature should be monitored using J type thermocouples placed on the hottest part of the component (out of any direct air flow). See Mechanical Details for component locations.

Temperature Measurements at max. amb.	
Component	Max Temperature
T1	120°C
Q2	130°C
D1	130°C

Performance

(Input voltage: 115Vac)

Switching frequency ripple rated load

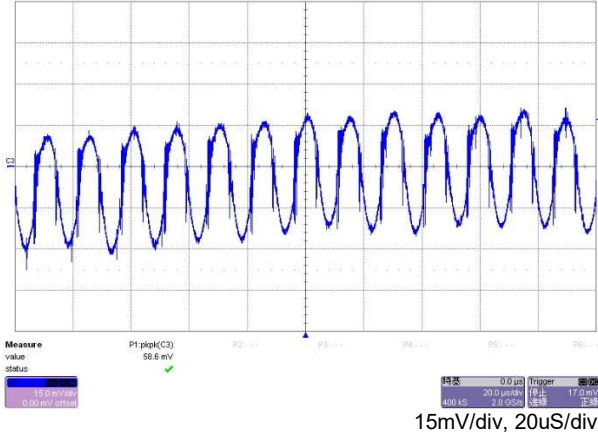

Line frequency ripple rated load

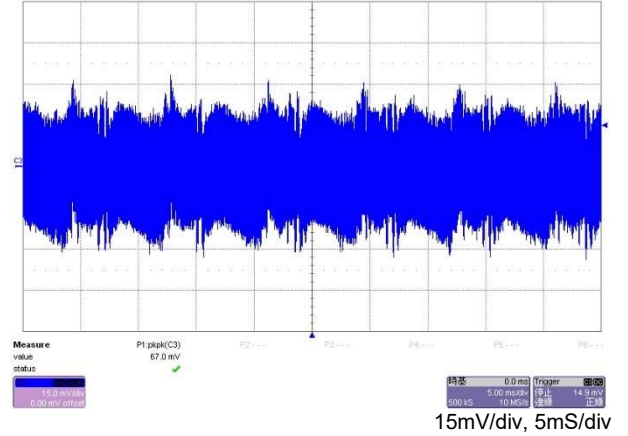

Output turn-on Max. load(264V)

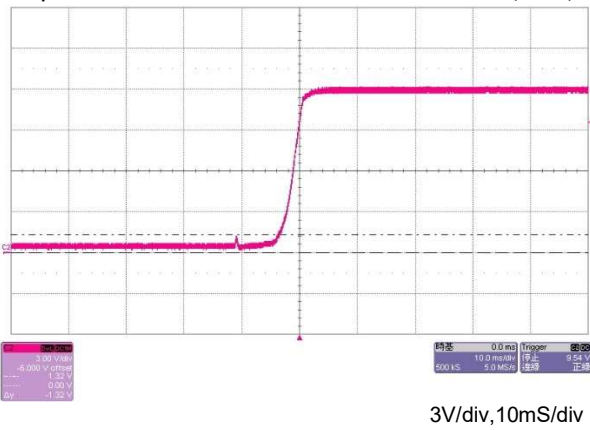

Output turn-off Max. load(264V)



Hold-up time Max. load

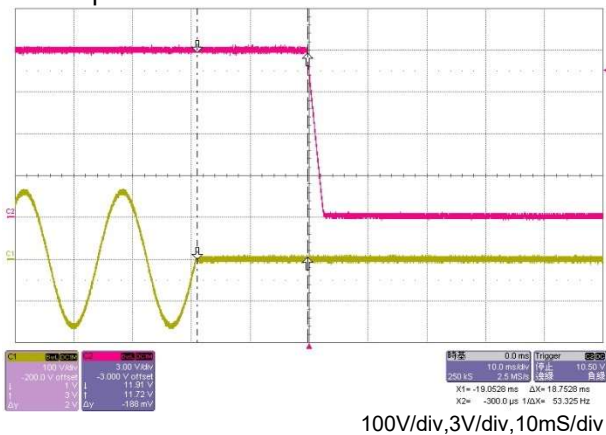

OVP 60% of rated load(264V)

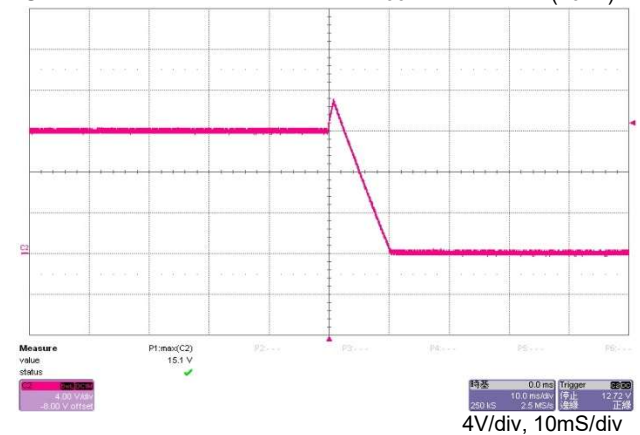

Step response

20%~100% of rated load

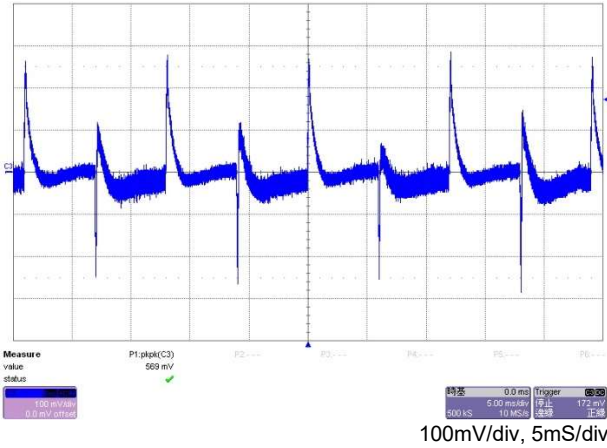

EMI: EN55011 "B" (Conduction)

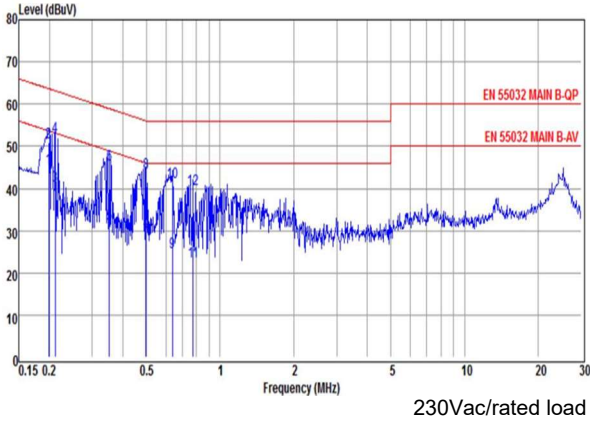

EMI: FCC "B" (Conduction)

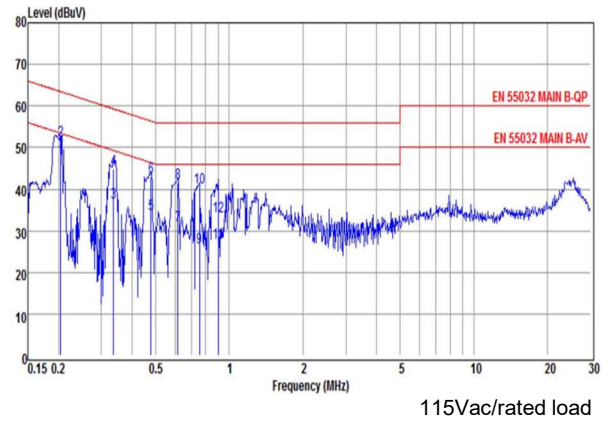

EMI: EN55011 "B" (Radiation)

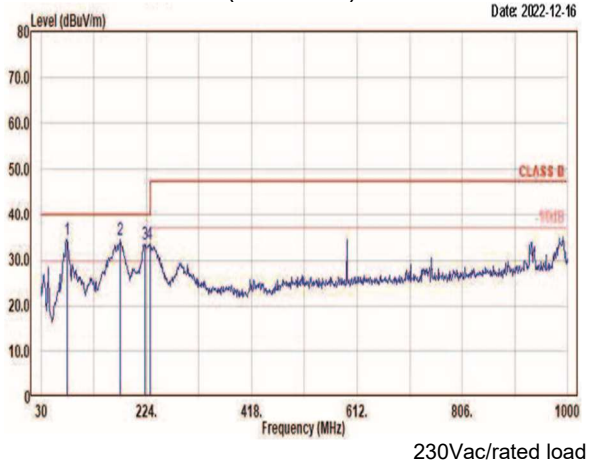

EMI: FCC "B" (Radiation)

