

SPECIFICATION
OF
SWITCHING POWER SUPPLY

For Flush Box

M/N: MPF-B045

Revision History		
Version	Revise Date	Change Items
Rev. 01	Feb. 9. 2021	Established.



FEATURES

- ✓ Potting power supply for installation into flush box in the wall.
- ✓ Rated 40W convection-cooled @ 50°C ambient.
- ✓ Potting in Heat-Resistant PC enclosure.
- ✓ Class II with Latch Off mode for short-circuited protection.
- ✓ Designed to meet ITE standard EN 62368-1, 2nd Edition EN 60335-1 for Household Appliances.
- ✓ Meet EMI CISPR 32 / FCC Part 15 class B.



Models & Ratings

Model Number	Rated Wattage	Output Voltage	Min. Current	Rated Current
MPF-B045	40 W	+24 V	0 A	1.67 A

Total Output Power: Rated. 40W with convection cooled at 50°C environment temperature.

Input

Characteristic	Minimum	Typical	Maximum	Units	Notes & Conditions
Input Voltage	184	230*	264	VAC	input range. *230VAC -20% + 15%
Input Frequency	47	50 / 60	63	Hz	AC input.
Input Current			0.5	A	Nominal AC Input Voltage (230VAC), rated load.
Earth Leakage Current			0.25	mA	Class II
No-load power consumption			0.15	W	Nominal AC Input Voltage (230VAC)
Input Protection	One non-user serviceable internally located AC input line fuse. Fuse : 2A / 250VAC * 1pc				

Output

Characteristic	Minimum	Typical	Maximum	Units	Notes & Conditions
Output Voltage		24		VDC	
Output current		1.67		A	
Efficiency	85	87		%	Nominal AC Input Voltage(230VAC) , rated load.
Initial Set Accuracy		±2		%	Initial setting accuracy is at Input 230VAC and output at 60% rated load.
Minimum Load		0		A	
Hold Up Time		10		mS	Nominal AC Input Voltage (230VAC), rated load.
Line Regulation		±0.5		%	Less than ±0.5% at rated load with ±10% changing in input voltage 230VAC.
Load Regulation		±0.5		%	Measured from 60% to 100% rated load and from 60% to 20% rated load (60% ±40% rated load).
Ripple & Noise		120		mV	Measured at rated load and Nominal AC Input Voltage (230VAC) by a 20MHz bandwidth limited oscilloscope and the each output is connected with a 10µF Electrolytic Capacitor and a 0.1µF Ceramic Capacitor.
Overload Protection	The build-in over load protection circuit will latch off the outputs to prevent damaging external circuits, the trigger point is around 105%~140% of peak output load.				
Over Temperature Protection	When the power supply operating over the temperature or over load limit, the power supply will be shut down automatically to protect itself. (Latch Off)				
Short Circuit Protection	Fully protected against output short-circuited. (Latch Off)				

Environmental

Characteristic	Minimum	Typical	Maximum	Units	Notes & Conditions
Operating Temperature	-20		+50	°C	Please refer to the de-rating curves. In order to stabilize within specifications, it needs to warm up from negative Celsius temperature.
Storage Temperature	-40		+85	°C	
Relative Humidity	5		95	%RH	Non-condensing.
Operating Altitude		5000		m	

Derating curve

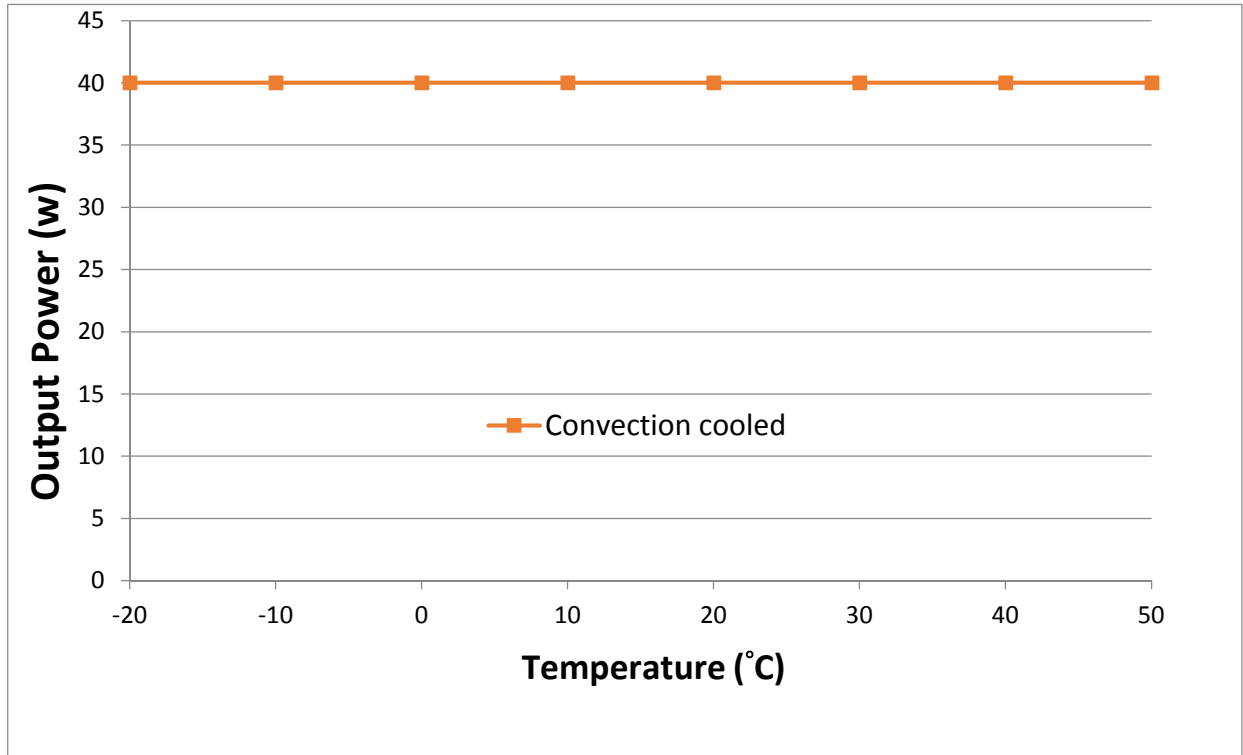

EMC: Emissions

Phenomenon	Standard	Class	Notes & Conditions
Conducted	EN 55032, CISPR 32 & FCC Part 15	B	
Radiated	EN 55032, CISPR 32 & FCC Part 15	B	
Harmonic Current	EN 61000-3-2	A	
Voltage Flicker	EN 61000-3-3	Pass	

EMC: Immunity

Phenomenon	Standard	Criteria	Notes & Conditions
ESD	IEC 61000-4-2	A	±8KV air discharge, ±6KV contact discharge
Radiated	IEC 61000-4-3	A	10V/m
EFT	IEC 61000-4-4	A	±2KV Line
Surges	IEC 61000-4-5	A	L-N:±1KV
Conducted	IEC 61000-4-6	A	10V
Power Magnetic	IEC 61000-4-8	A	10A/m
Dips and Interruptions	IEC 61000-4-11	A A B B	DIP: >95%, 0.5 cycle DIP: 30%, 25 cycles DIP: 60%, 5 cycles INT: >95%, 250 cycles

Safety Approvals

Characteristic	Minimum	Typical	Maximum	Units	Notes & Conditions
Isolation	IP to OP	3000		VAC	
Safety Agency	Safety Standard				Notes & Conditions
CE-LVD	EN 62368-1:2014 + A11: 2017 EN 60335-1				Designed to meet.
UL/cUL	UL 62368-1, 2nd Edition, CSA C22.2 No. 62368-1-14, 2nd Edition				Designed to meet.
CB	IEC 62368-1:2014 (Second Edition)				Designed to meet.

Mechanical Details

Unit: mm Tolerance +/- 0.5mm.

52 (L) * 44.2 (W) * 38 (H) mm, Tolerance +/- 0.5mm. (Fitting flush box in the wall)

Weight : 130g

Caution! This power supply is especially designed for **use in the flush box in wall**.

It is NOT normal adapter (external power) and should be regarded as part or component of the end user application.

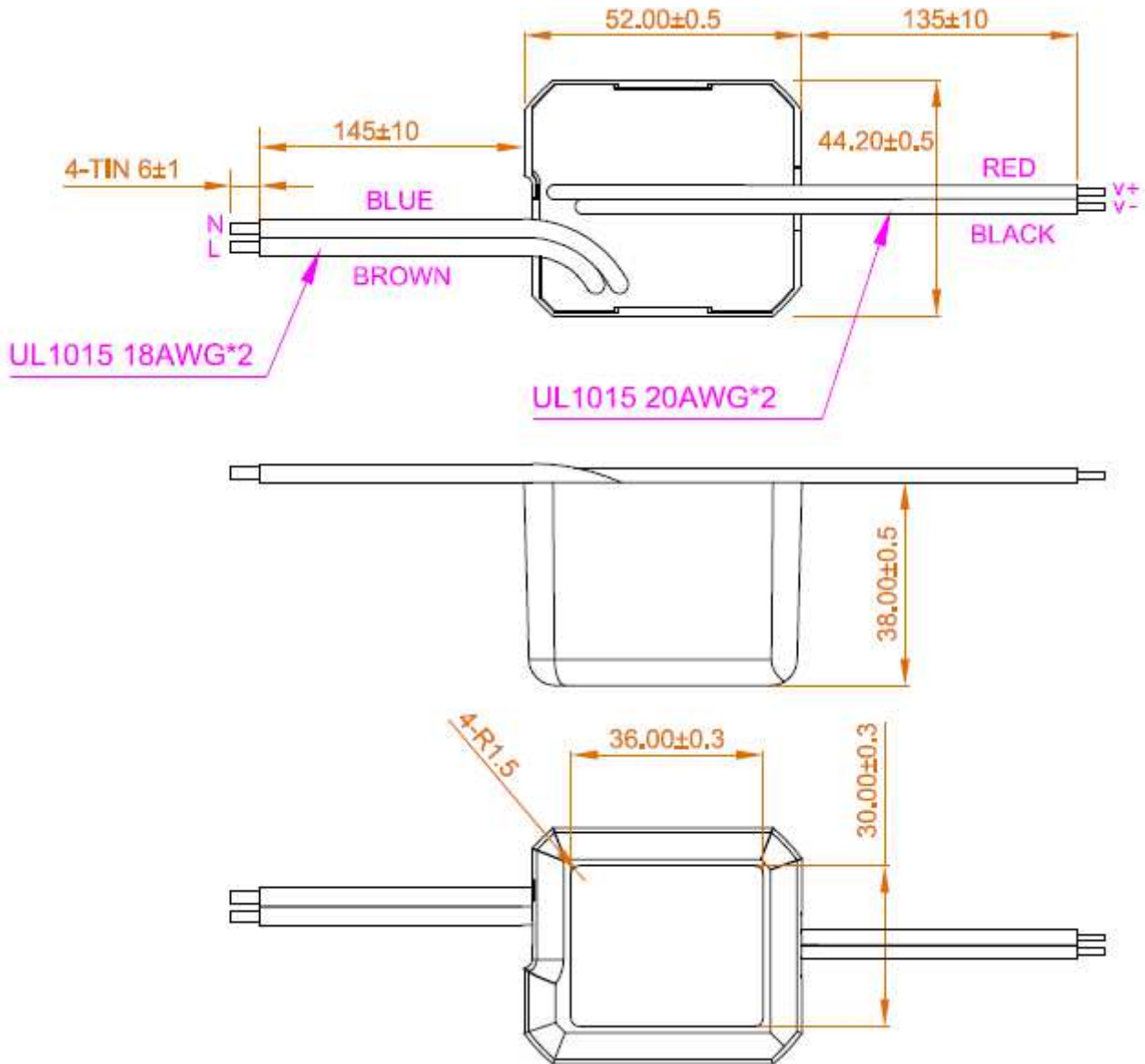

Performance

(Input voltage: 184Vac)

Switching frequency ripple rated load

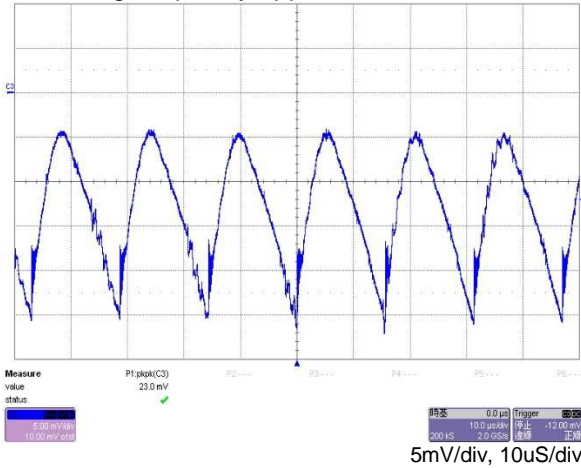

Line frequency ripple rated load

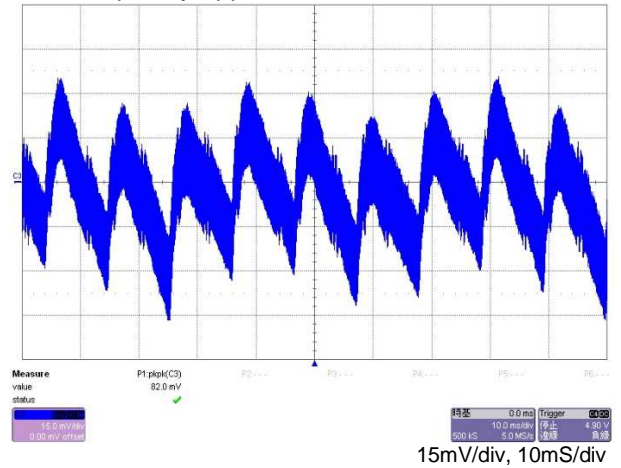

Output turn-on rated load

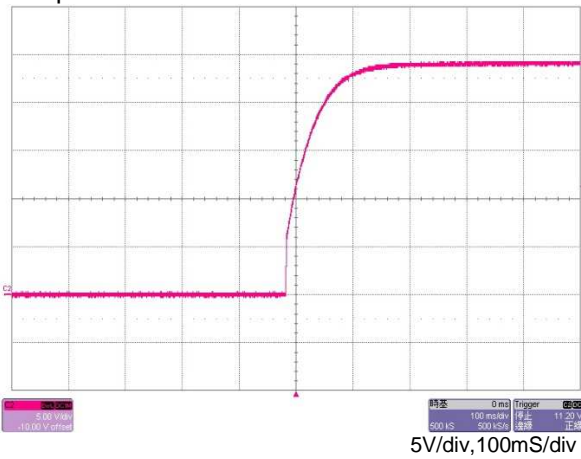

Output turn-off rated load



Hold-up time rated load

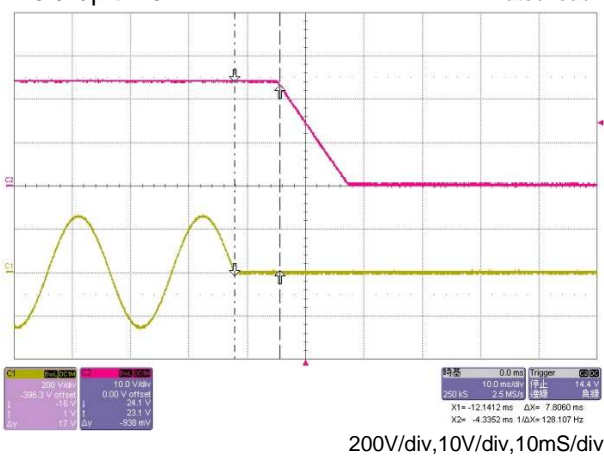

Step response 20%~100% of Max. load

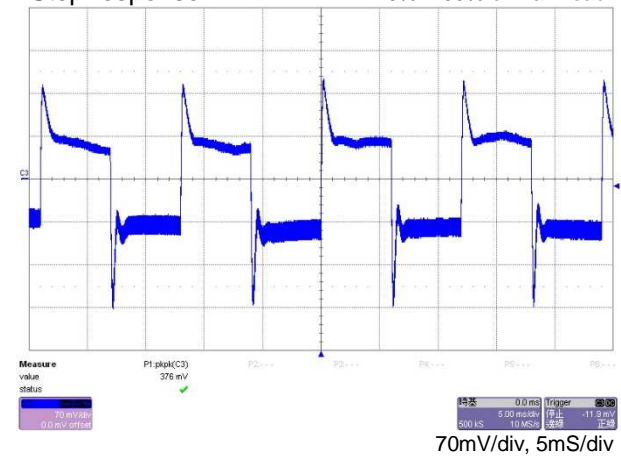

EMI: EN55011 "B" (Conduction)

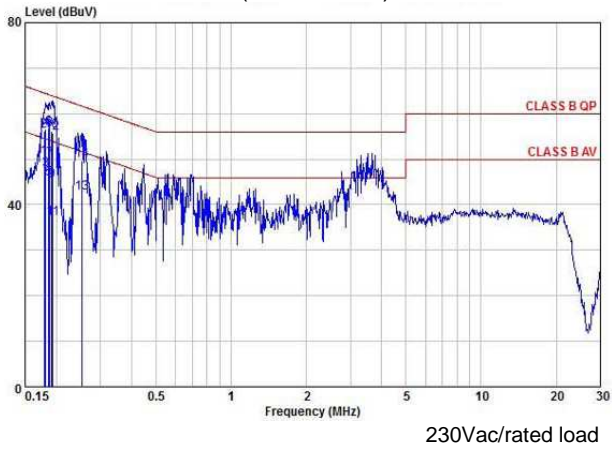

EMI: EN55011 "B" (Radiation)

