

**SPECIFICATION**

**For**

**SWITCHING POWER SUPPLY**

**M/N: MPE-J066 (48V / 1.35A)**



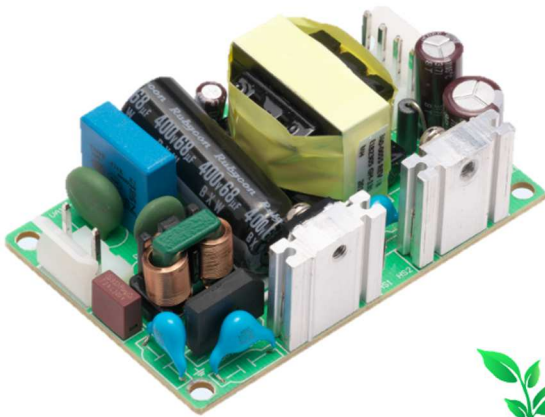

## FEATURES

- ✓ 65W with Forced-air cooling @ 80°C ambient.
- ✓ Wide operating temperature -40~80°C.
- ✓ Compact size 2" x 3" with low profile 1".
- ✓ High efficiency up to 90%.
- ✓ No-load power consumption < 0.2W.
- ✓ Low inrush current.
- ✓ Class II, & class I with functional ground connected.
- ✓ Safety Approvals ITE standard IEC, EN, UL 62368-1, 2nd Edition.
- ✓ Meets EMI CISPR 22 / FCC Part 15 class B.



## Models & Ratings

Model Number	Wattage (Rated / Max)	Output Voltage	Min. Current	Rated Current	Max. Current
MPE-J066	50 W / 65 W	+48 V	0 A	1.04 A	1.35 A

Total Output Power: Max. 50W with convection cooled at 50°C environment temperature, Max. 65W with 7 CFM.

Note:

1. Model no. coding:

**MPE-J06X-Y**



1	X =	Output (V)
	2	+5
	3	+12
	5	+24
	6	+48

2	Y =	Input / Output Connector Type
	blank	Molex Type Connector or equivalent (Standard Product)
	J	JST Type Connector or equivalent

## Summary

Characteristic	Minimum	Typical	Maximum	Units	Notes & Conditions
Input Range	85	115 / 230	264	VAC	Continuous input range.
	130		370	VDC	Only for electrical function. In safety approvals, it is considered and applied AC input version.
Input Frequency	47	50 / 60	63	Hz	AC input.
Efficiency		88 / 90		%	Nominal AC Input Voltage(115/230VAC).
Operation Temperature	-40*		+80	°C	*Can be started up / activated at -40C. In order to stabilize within specification, it needs to <b>warm up</b> at negative temperature. Please refer to the derating curves.
Weight		77.8		g	
Dimensions	76.2 (L) x 50.8 (W) x 25.0 (H) mm, Tolerance +/- 0.5mm.				
EMC	EN 55022 / EN 55032, CISPR 22 & FCC Part 15, EN 61000-3-2, EN 61000-3-3 IEC 61000-4-2, IEC 61000-4-3, IEC 61000-4-4, IEC 61000-4-5, IEC 61000-4-6, IEC 61000-4-8, IEC 61000-4-11				
Safety Approvals	IEC 62368-1, UL 62368-1, 2nd Edition, CSA C22.2 No. 62368-1-14, 2nd Edition				

## Input

Characteristic	Minimum	Typical	Maximum	Units	Notes & Conditions
Input Voltage	85	115 / 230	264	VAC	Universal input range.
	130		370	VDC	Only for electrical function. In safety approvals, it is considered and applied AC input version.
Input Frequency	47	50 / 60	63	Hz	AC input.
Input Current			1.5 / 0.8	A	Nominal AC Input Voltage (115VAC/230VAC), rated load.
Inrush Current			40	A	Nominal AC Input Voltage (115VAC/230VAC), one cycle at 25°C cold start.
Earth Leakage Current			0.25	mA	
No-load power consumption			0.2	W	
Input Protection	One non-user serviceable internally located AC input line fuse. Fuse : 2A / 250VAC * 1pcs				

## Output

Characteristic	Minimum	Typical	Maximum	Units	Notes & Conditions
Output Voltage		48		VDC	
Output current		1.04	1.35	A	
Initial Set Accuracy		±2		%	Initial setting accuracy is at Input 115VAC and output at 60% rated load.
Minimum Load		0		A	
Start Up Delay		1	3.5	Sec	Time required for initial output voltage stabilization.
Hold Up Time		9 / 50		mS	Nominal AC Input Voltage (115VAC/230VAC), rated load.
Line Regulation		±0.5		%	Less than ±0.5% at rated load with ±10% changing in input voltage 115/230VAC.
Load Regulation		±1		%	Measured from 60% to 100% rated load and from 60% to 20% rated load (60% ±40% rated load).
Ripple & Noise		240		mV	Measured at rated load and Nominal AC Input Voltage (115VAC/230VAC) by a 20MHz bandwidth limited oscilloscope and the each output is connected with a 10µF Electrolytic Capacitor and a 0.1µF Ceramic Capacitor.
Oversoltage Protection	The build-in over voltage protection circuit will auto recovery the outputs to prevent damaging external circuits, the trigger point is around 110%~130% of output voltage.				
Overload Protection	Automatic recovery.				
Short Circuit Protection	Fully protected against output short circuit. Automatic recovery.				

## General

Characteristic		Minimum	Typical	Maximum	Units	Notes & Conditions
Efficiency			88 / 90		%	Nominal AC Input Voltage(115/230VAC).
Isolation	IP to OP	3000			VAC	
	IP to GND	1800			VAC	
Switching Frequency			65		KHZ	

## Environmental

Characteristic		Minimum	Typical	Maximum	Units	Notes & Conditions
Operating Temperature		-40*		+80	°C	*Can be started up / activated at -40C. In order to stabilize within specification, it needs to <b>warm up</b> at negative temperature. Please refer to the derating curves as following.
Storage Temperature		-40		+85	°C	
Relative Humidity		5		95	%RH	Non-condensing.
Cooling		7			CFM	
Operating Altitude			4000		m	
Vibration		0.26		6.09	G	Frequency Type: Sweep Frequency Frequency Range: 10~55 Hz Displacement: 1.0mm Sweep Rate: 60 minute / cycle Number of cycle: 1 cycle / axis Direction: X ,Y and Z axis

## Derating curve

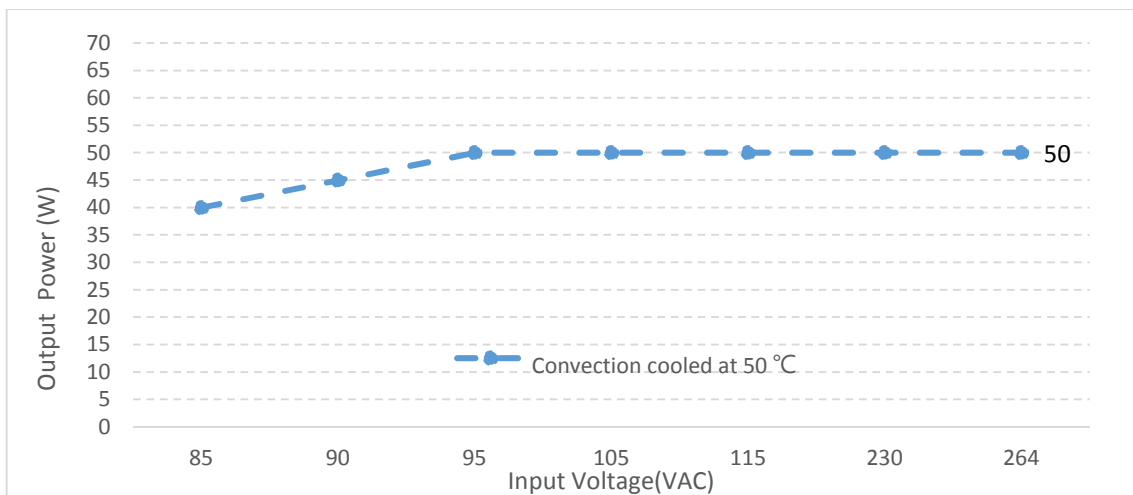
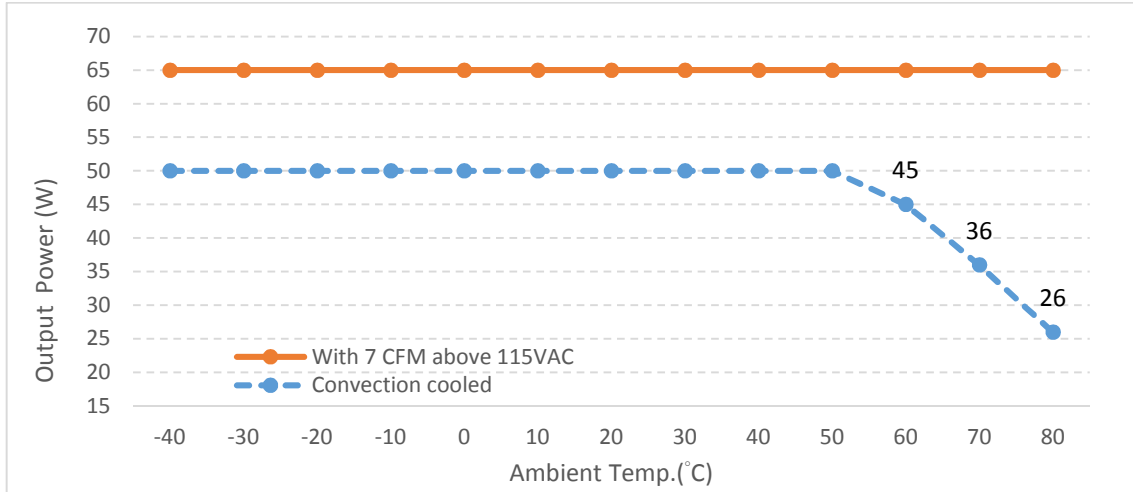

## EMC: Emissions

Phenomenon	Standard	Class	Notes & Conditions
Conducted	EN 55022 / EN 55032, CISPR 22 & FCC Part 15	B	
Radiated	EN 55022 / EN 55032, CISPR 22 & FCC Part 15	B	
Harmonic Current	EN 61000-3-2	A	
Voltage Flicker	EN 61000-3-3	Pass	

## EMC: Immunity

Phenomenon	Standard	Criteria	Notes & Conditions
ESD	IEC 61000-4-2	A	±8KV air discharge, ±6KV contact discharge
Radiated	IEC 61000-4-3	A	10V/m
EFT	IEC 61000-4-4	A	±2KV Line & PE
Surges	IEC 61000-4-5	A	L-N:±1KV, L/N-PE:±2KV
Conducted	IEC 61000-4-6	A	10V
Power Magnetic	IEC 61000-4-8	A	10A/m
Dips and Interruptions	IEC 61000-4-11	A / B A / B A / B B	DIP: >95%, 0.5 cycle <sup>(Note 1)</sup> DIP: 30%, 25 cycles <sup>(Note 1)</sup> DIP: 60%, 5 cycles <sup>(Note 1)</sup> INT: >95%, 250 cycles

Note:

1. The test result of input 240Vac / 100Vac is criteria A / B.
2. For Class II AC input radiation, recommended to add core EROCORE A8I280200160 4 turns.

## Safety Approvals

Safety Agency	Safety Standard	Notes & Conditions
CB	IEC 62368-1, 2nd Edition	Approved.
UL/cUL	UL 62368-1, 2nd Edition, CSA C22.2 No. 62368-1-14, 2nd Edition	Approved.

## Mechanical Details

Unit: mm

SIZE : 76.2(L) x 50.8(W) x 25(H)mm, Tolerance +/-0.5mm.

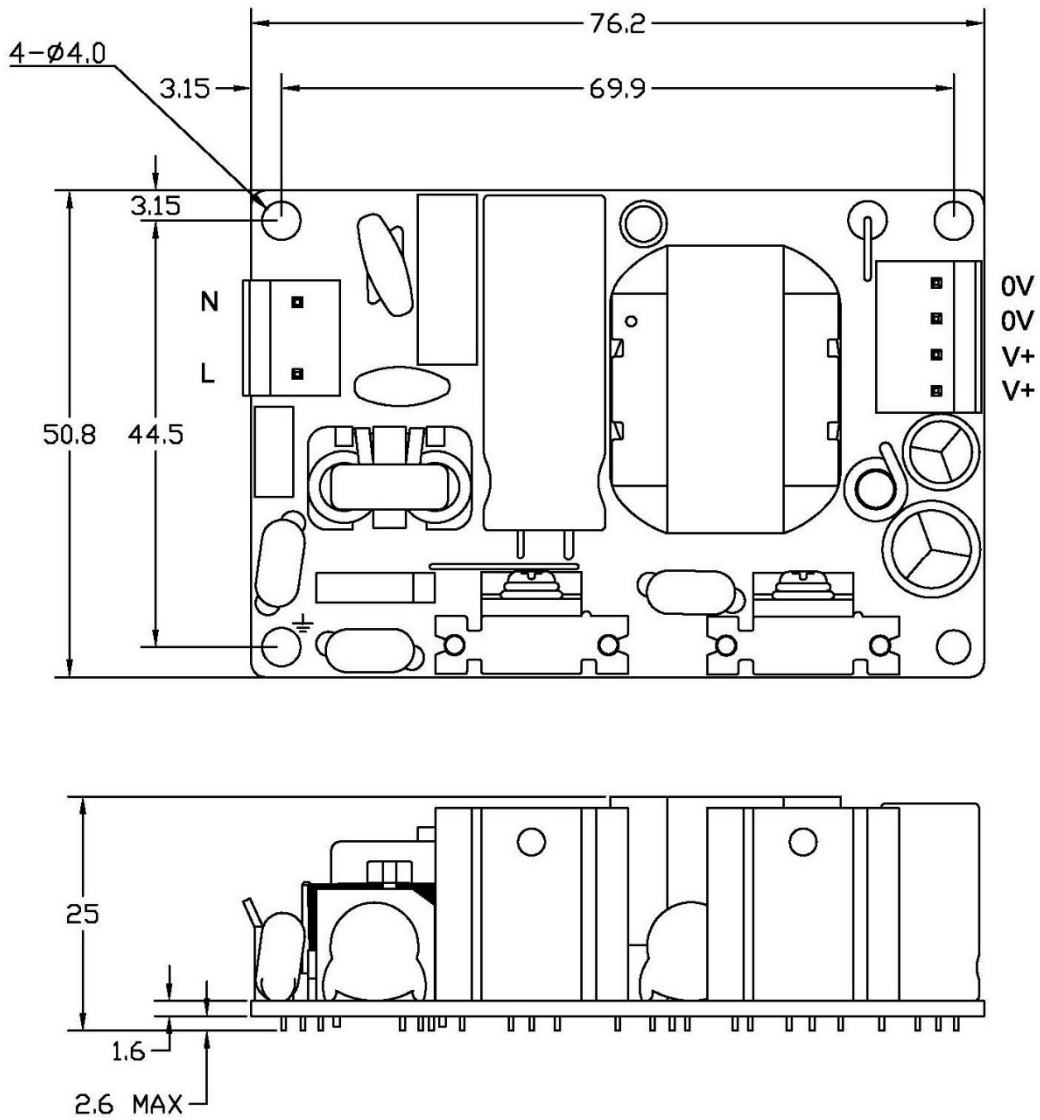



Parameter	Conditions/Description					
Dimension	76.2 (L) x 50.8 (W) x 25 (H) mm, Tolerance +/- 0.5mm.					
Connector & Pin Assignment	CN1 (Input)	Pin		Assignment	Proposed Housing	Proposed Terminals
		MX 1	JT 3	AC in (N)	MOLEX: 09-50-1031 (5195-03) or 09-52-4034 (5239-03) or equivalent	
		MX 2	JT 2	N / A		
	MX 3	JT 1	AC in (L)	JST: VHR-3N or equivalent (Note 1)	JST: SVH-21T-P1.1 or equivalent (Note 1)	
	CN2 (Output)	MX 1	JT 4	+ V	MOLEX: 09-50-1041 (5195-04) or 09-52-4044 (5239-04); or equivalent	MOLEX: 5194 or 5225, 2478, 2578, 5176 or 5168 or equivalent
		MX 2	JT 3	+ V		
		MX 3	JT 2	0 V	JST: VHR-4N or equivalent (Note 1)	JST: SVH-21T-P1.1 or equivalent (Note 1)
		MX 4	JT 1	0 V		

Note 1. Exist with model no. suffixed -J, please see the detail in Model no. coding.

2. The pin assignment "MX" for Molex type connector or equivalent, "JT" for JST type connector or equivalent.

## Thermal Considerations

In order to ensure safe operation of the PSU in the end-use equipment, the temperature of the components listed in the table below must not be exceeded.

Temperature should be monitored using J type thermocouples placed on the hottest part of the component (out of any direct air flow). See Mechanical Details for component locations.

Temperature Measurements at max. amb.	
Component	Max Temperature
T1	110°C
Q1	115°C
D5	95°C
C2	100°C
C21	85°C

### Performance

(Input voltage: 230Vac)

Switching frequency ripple rated load

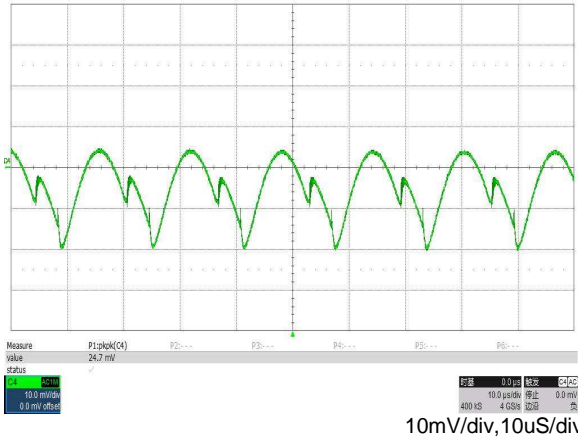

Line frequency ripple rated load

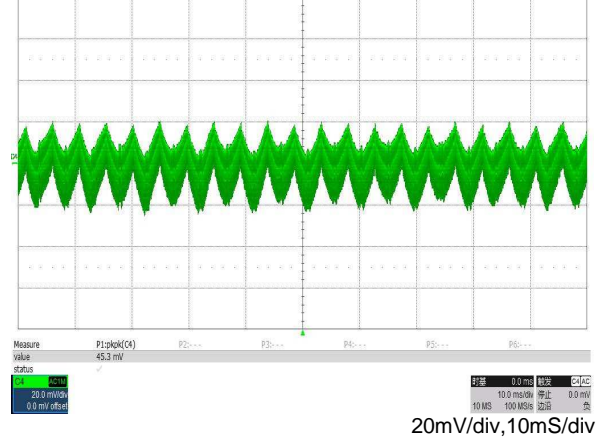

Output turn-on rated load

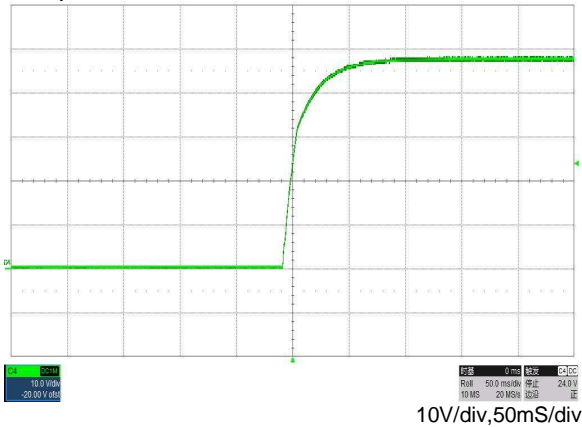

Output turn-off rated load

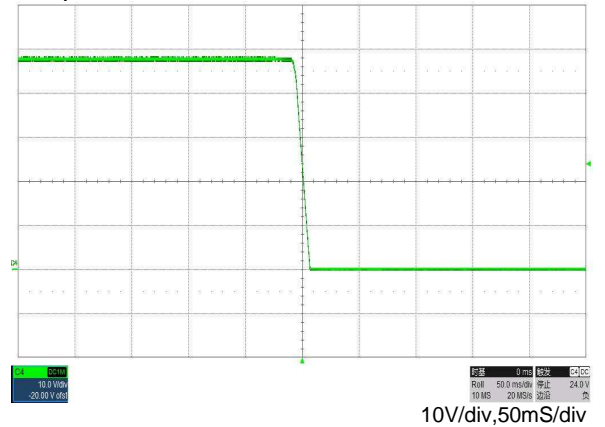

Hold-up time rated load

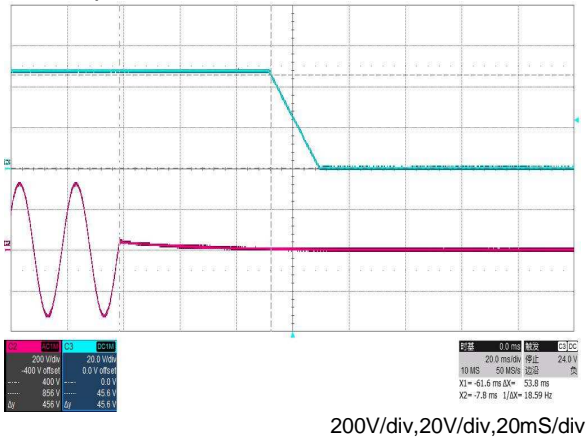

OVP 60% of rated load



## Step response 20%~100% of rated load

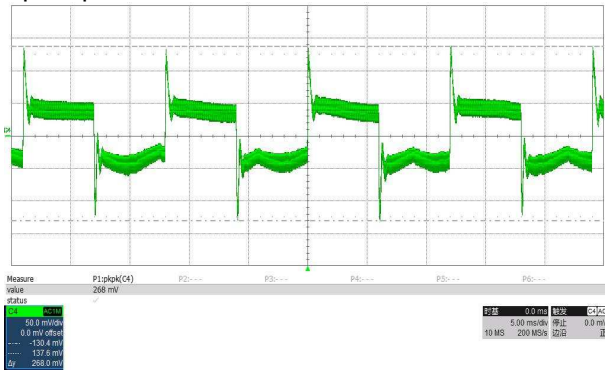

## EMI: EN 55032 "B" (Conduction)

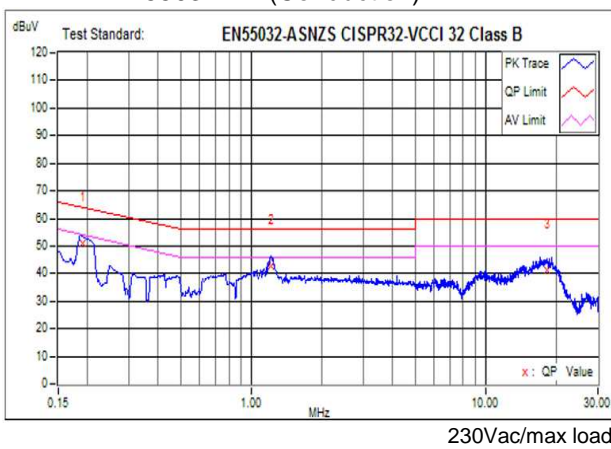

## EMI: FCC "B" (Conduction)

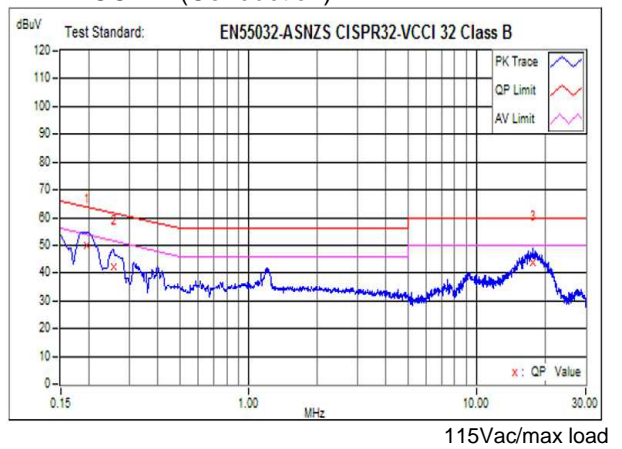

## EMI: EN 55032 "B" (Radiation)

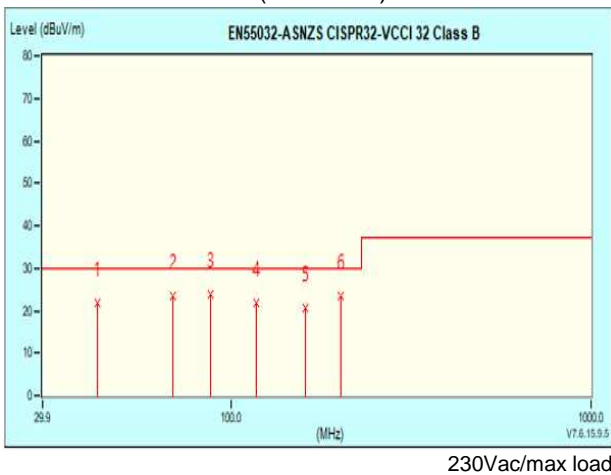

## EMI: FCC "B" (Radiation)

