

SPECIFICATION

For

SWITCHING POWER SUPPLY

M/N: MPE-J063 (12V / 5.42A)

Revision History

| Version | Revise Date | Change Items |
|---------|---------------|--------------------------------|
| Rev. 01 | May. 13. 2020 | Established. |
| Rev. 02 | Jul. 20. 2020 | Changed Operating Temperature. |
| | | |
| | | |
| | | |
| | | |
| | | |
| | | |
| | | |
| | | |
| | | |
| | | |
| | | |
| | | |
| | | |
| | | |
| | | |
| | | |
| | | |
| | | |
| | | |
| | | |
| | | |
| | | |
| | | |
| | | |

MPE-J063

12V / 5.42 A AC / DC

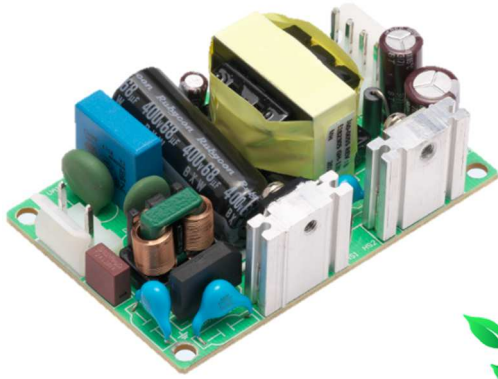

FEATURES

- ✓ 65W with Forced-air cooling @ 80°C ambient.
- ✓ Wide operating temperature -40~80°C.
- ✓ Compact size 2" x 3" with low profile 1".
- ✓ No-load power consumption < 0.2W.
- ✓ Low inrush current.
- ✓ Class II, & Class I with functional ground connected.
- ✓ Safety Approvals ITE standard IEC, EN, UL 62368-1, 2nd Edition.
- ✓ Meets EMI CISPR 22 / FCC Part 15 class B.



Models & Ratings

| Model Number | Wattage (Rated / Max) | Output Voltage | Min. Current | Rated Current | Max. Current |
|--------------|-----------------------|----------------|--------------|---------------|--------------|
| MPE-J063 | 50 W / 65 W | +12 V | 0 A | 4.16 A | 5.42 A |

Total Output Power: Max. 50W with convection cooled at 50°C environment temperature, Max. 65W with 7 CFM.

Note:

1. Model no. coding:

MPE-J06X-Y

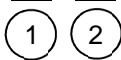

| 1 | X = | Output (V) |
|---|-----|------------|
| | 2 | +5 |
| | 3 | +12 |
| | 5 | +24 |
| | 6 | +48 |

| 2 | Y= | Input / Output Connector Type |
|---|-------|---|
| | blank | Molex Type Connector or equivalent (Standard Product) |
| | J | JST Type Connector or equivalent |

Summary

| Characteristic | Minimum | Typical | Maximum | Units | Notes & Conditions |
|-----------------------|---|-----------|---------|-------|--|
| Input Range | 85 | 115 / 230 | 264 | VAC | Continuous input range. |
| | 130 | | 370 | VDC | Only for electrical function. In safety approvals, it is considered and applied AC input version. |
| Input Frequency | 47 | 50 / 60 | 63 | Hz | AC input. |
| Efficiency | | 86 / 88 | | % | Nominal AC Input Voltage(115/230VAC). |
| Operation Temperature | -40* | | +80 | °C | *Can be started up / activated at -40C. In order to stabilize within specification, it needs to warm up at negative temperature. Please refer to the derating curves. |
| Weight | | 77.6 | | g | |
| Dimensions | 76.2 (L) x 50.8 (W) x 25 (H) mm, Tolerance +/- 0.5mm. | | | | |
| EMC | EN 55022 / EN 55032, CISPR 22 & FCC Part 15, EN 61000-3-2, EN 61000-3-3 IEC 61000-4-2, IEC 61000-4-3, IEC 61000-4-4, IEC 61000-4-5, IEC 61000-4-6, IEC 61000-4-8, IEC 61000-4-11 | | | | |
| Safety Approvals | IEC 62368-1, UL 62368-1, 2nd Edition, CSA C22.2 No. 62368-1-14, 2nd Edition | | | | |

Input

| Characteristic | Minimum | Typical | Maximum | Units | Notes & Conditions |
|---------------------------|--|-----------|-----------|-------|---|
| Input Voltage | 85 | 115 / 230 | 264 | VAC | Universal input range. |
| | 130 | | 370 | VDC | Only for electrical function. In safety approvals, it is considered and applied AC input version. |
| Input Frequency | 47 | 50 / 60 | 63 | Hz | AC input. |
| Input Current | | | 1.5 / 0.8 | A | Nominal AC Input Voltage (115VAC/230VAC), rated load. |
| Inrush Current | | | 40 | A | Nominal AC Input Voltage (115VAC/230VAC), one cycle at 25°C cold start. |
| Earth Leakage Current | | | 0.25 | mA | |
| No-load power consumption | | | 0.2 | W | |
| Input Protection | One non-user serviceable internally located AC input line fuse. Fuse : 2A / 250VAC * 1 pcs | | | | |

Output

| Characteristic | Minimum | Typical | Maximum | Units | Notes & Conditions |
|--------------------------|---|---------|---------|-------|--|
| Output Voltage | | 12 | | VDC | |
| Output current | | 4.16 | 5.42 | A | |
| Initial Set Accuracy | | ±2 | | % | Initial setting accuracy is at Input 115VAC and output at 60% rated load. |
| Minimum Load | | 0 | | A | |
| Start Up Delay | | 1 | 3.5 | Sec | Time required for initial output voltage stabilization. |
| Hold Up Time | | 9 / 50 | | mS | Nominal AC Input Voltage (115/230VAC), rated load. |
| Line Regulation | | ±0.5 | | % | Less than ±0.5% at rated load with ±10% changing in input voltage 115/230VAC. |
| Load Regulation | | ±1 | | % | Measured from 60% to 100% rated load and from 60% to 20% rated load (60% ±40% rated load). |
| Ripple & Noise | | 120 | | mV | Measured at rated load and Nominal AC Input Voltage (115VAC/230VAC) by a 20MHz bandwidth limited oscilloscope and the each output is connected with a 10µF Electrolytic Capacitor and a 0.1µF Ceramic Capacitor. |
| Overvoltage Protection | The build-in over voltage protection circuit will auto recovery the outputs to prevent damaging external circuits, the trigger point is around 110%~140% of output voltage. | | | | |
| Overload Protection | Automatic recovery. | | | | |
| Short Circuit Protection | Fully protected against output short circuit. Automatic recovery. | | | | |

General

| Characteristic | Minimum | Typical | Maximum | Units | Notes & Conditions |
|---------------------|-----------|---------|---------|-------|---------------------------------------|
| Efficiency | | 86 / 88 | | % | Nominal AC Input Voltage(115/230VAC). |
| Isolation | IP to OP | 3000 | | VAC | |
| | IP to GND | 1800 | | VAC | |
| Switching Frequency | | 65 | | KHZ | |

Environmental

| Characteristic | Minimum | Typical | Maximum | Units | Notes & Conditions |
|-----------------------|---------|---------|---------|-------|---|
| Operation Temperature | -40* | | +80 | °C | *Can be started up / activated at -40C. In order to stabilize within specification, it needs to warm up at negative temperature. Please refer to the derating curves as following. |
| Storage Temperature | -40 | | +85 | °C | |
| Relative Humidity | 5 | | 95 | %RH | Non-condensing. |
| Cooling | 7 | | | CFM | |
| Operating Altitude | | 4000 | | m | |
| Vibration | 0.26 | | 6.09 | G | Frequency Type: Sweep Frequency Frequency Range: 10~55 Hz Displacement: 1.0mm Sweep Rate: 60 minute / cycle Number of cycle: 1 cycle / axis Direction: X ,Y and Z axis |

Derating curve

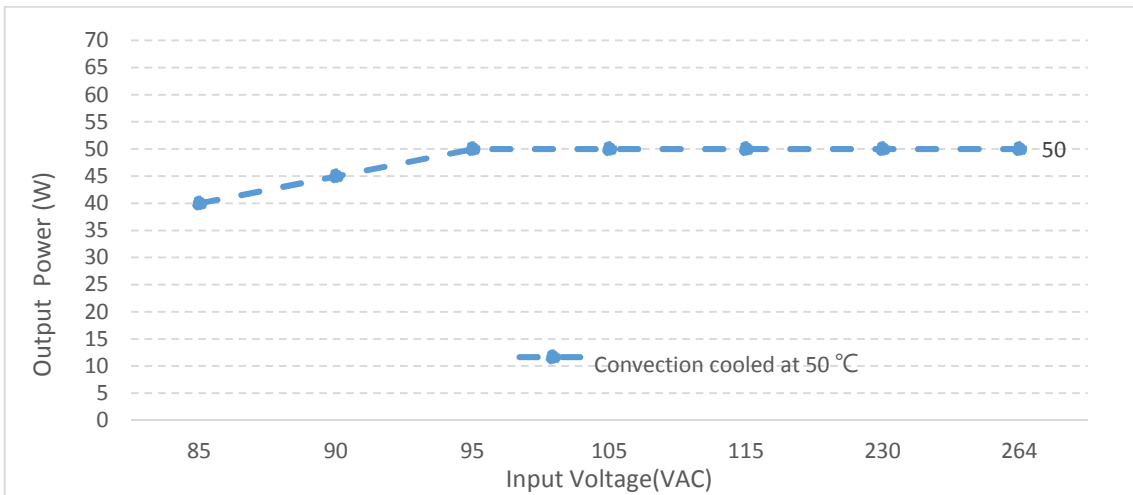
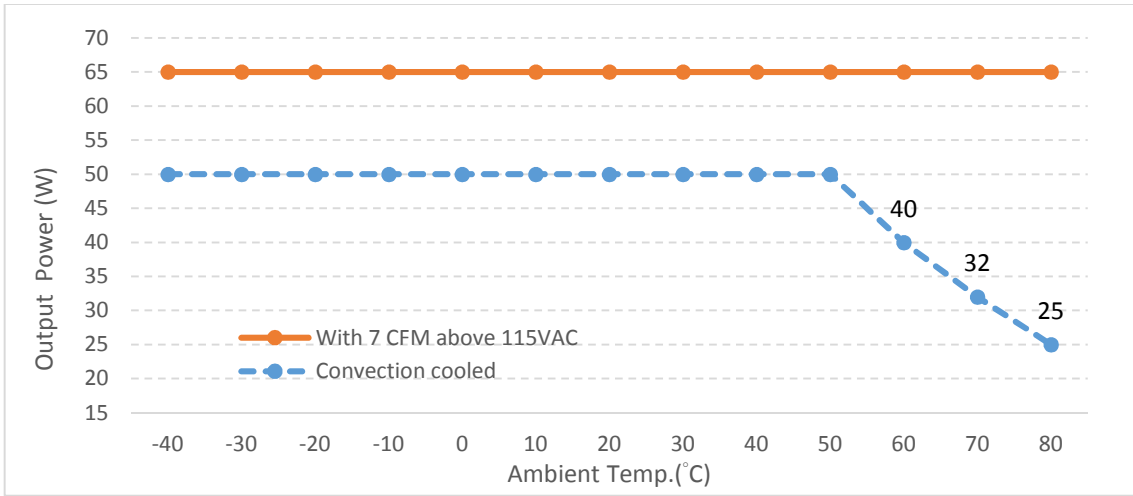

EMC: Emissions

| Phenomenon | Standard | Class | Notes & Conditions |
|------------------|---|-------|--------------------|
| Conducted | EN 55022 / EN 55032, CISPR 22 & FCC Part 15 | B | |
| Radiated | EN 55022 / EN 55032, CISPR 22 & FCC Part 15 | B | |
| Harmonic Current | EN 61000-3-2 | A | |
| Voltage Flicker | EN 61000-3-3 | Pass | |

EMC: Immunity

| Phenomenon | Standard | Criteria | Notes & Conditions |
|------------------------|----------------|------------------------------|--|
| ESD | IEC 61000-4-2 | A | ±8KV air discharge, ±6KV contact discharge |
| Radiated | IEC 61000-4-3 | A | 10V/m |
| EFT | IEC 61000-4-4 | A | ±2KV Line & PE |
| Surges | IEC 61000-4-5 | A | L-N:±1KV, L/N-PE:±2KV |
| Conducted | IEC 61000-4-6 | A | 10V |
| Power Magnetic | IEC 61000-4-8 | A | 10A/m |
| Dips and Interruptions | IEC 61000-4-11 | A / B A / B A / B B | DIP: >95%, 0.5 cycle ^(Note 1) DIP: 30%, 25 cycles ^(Note 1) DIP: 60%, 5 cycles ^(Note 1) INT: >95%, 250 cycles |

Note:

1. The test result of input 240Vac / 100Vac is criteria A / B.
2. For Class II AC input radiation, recommended to add core EROCORE A8I280200160 4 turns.

Safety Approvals

| Safety Agency | Safety Standard | Notes & Conditions |
|---------------|--|--------------------|
| CB | IEC 62368-1, 2nd Edition | Approved. |
| UL/cUL | UL 62368-1, 2nd Edition, CSA C22.2 No. 62368-1-14, 2nd Edition | Approved. |

Mechanical Details

Unit: mm
SIZE : 76.2(L) x 50.8(W) x 25(H)mm, Tolerance +/-0.5mm.

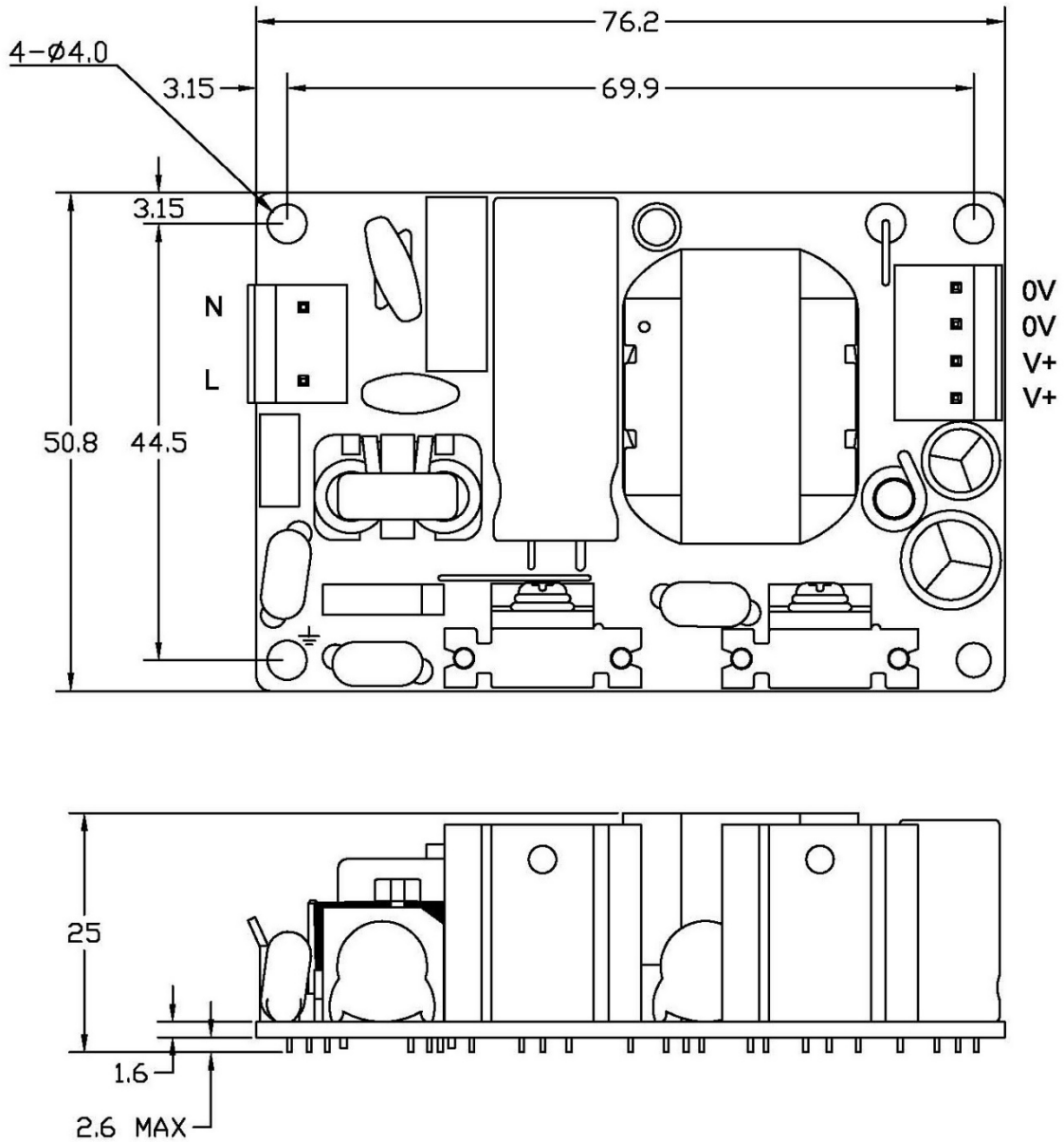

| Parameter | Conditions/Description | | | | |
|----------------------------|---|------|------------|---|---|
| Dimension | 76.2 (L) x 50.8 (W) x 25 (H) mm, Tolerance +/- 0.5mm. | | | | |
| Connector & Pin Assignment | Location | Pin | Assignment | Proposed Housing | Proposed Terminals |
| | CN1 (Input) | MX 1 | JT 3 | AC in (N) | MOLEX: 09-50-1031 (5195-03) or 09-52-4034 (5239-03) or equivalent |
| MX 2 | | JT 2 | N / A | | |
| MX 3 | | JT 1 | AC in (L) | JST: VHR-3N or equivalent (Note 1) | JST: SVH-21T-P1.1 or equivalent (Note 1) |
| CN2 (Output) | MX 1 | JT 4 | + V | MOLEX: 09-50-1041 (5195-04) or 09-52-4044 (5239-04) or equivalent | MOLEX: 5194 or 5225, 2478, 2578,5167 or 5168 or equivalent |
| | MX 2 | JT 3 | + V | | |
| | MX 3 | JT 2 | 0 V | JST: VHR-4N or equivalent (Note 1) | JST: SVH-21T-P1.1 or equivalent (Note 1) |
| | MX 4 | JT 1 | 0 V | | |

Note: 1. Exist with model no. suffixed -J, please see the detail in Model no. coding.

2.The pin assignment "MX" for Molex type connector or equivalent, "JT" for JST type connector or equivalent.

Thermal Considerations

In order to ensure safe operation of the PSU in the end-use equipment, the temperature of the components listed in the table below must not be exceeded.

Temperature should be monitored using J type thermocouples placed on the hottest part of the component (out of any direct air flow). See Mechanical Details for component locations.

| Temperature Measurements at max. amb. | |
|---------------------------------------|-----------------|
| Component | Max Temperature |
| T1 | 110°C |
| Q1 | 115°C |
| D5 | 115°C |
| C2 | 95°C |
| C21 | 90°C |

Performance

(Input voltage: 230Vac)

Switching frequency ripple rated load

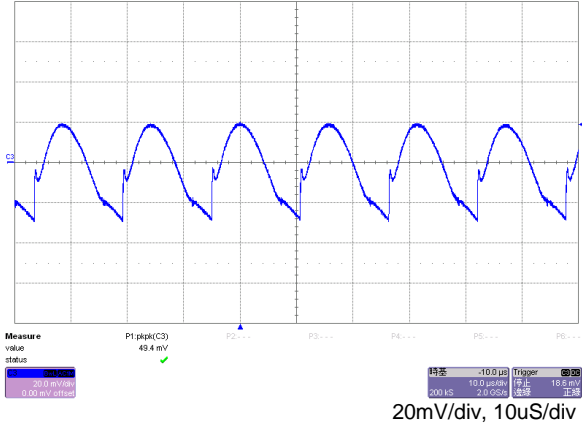

Line frequency ripple rated load

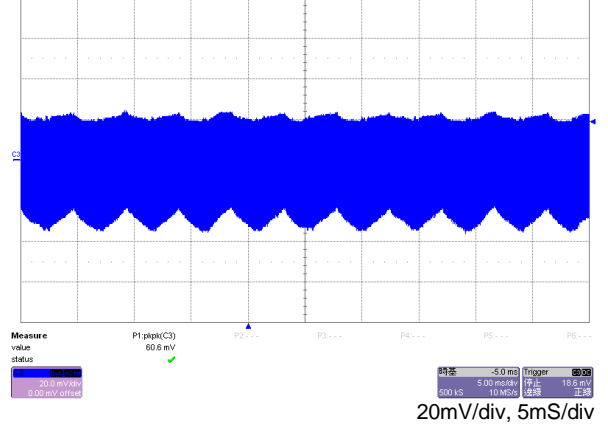

Output turn-on rated load

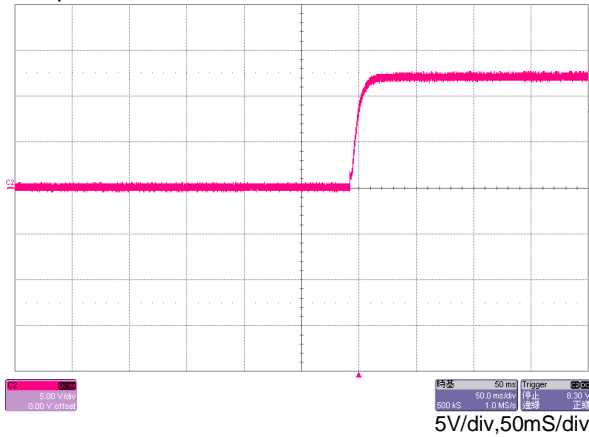

Output turn-off rated load

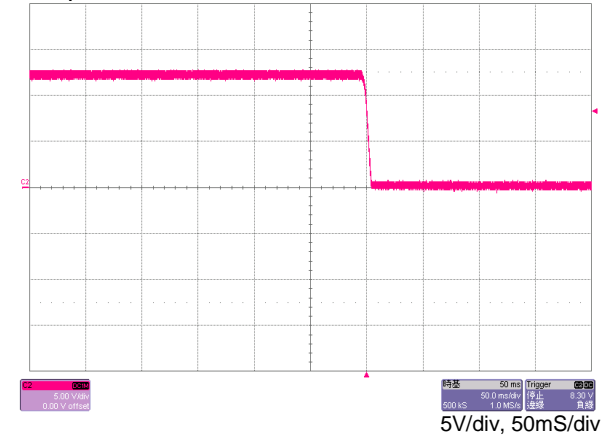

Hold-up time rated load

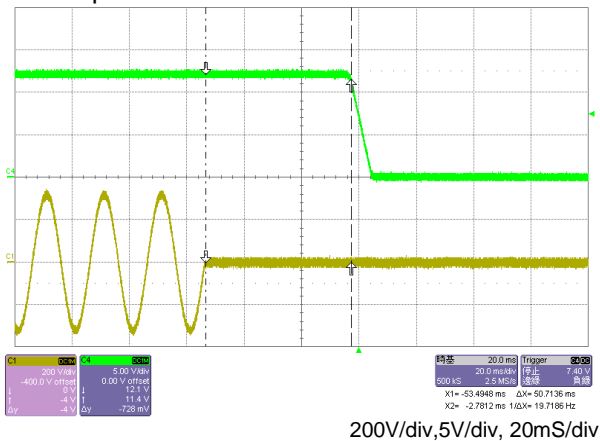

OVP 60% of rated load

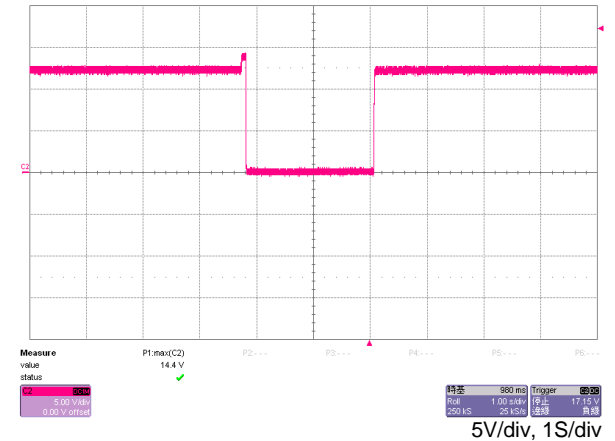

Step response 20%~100% of rated load

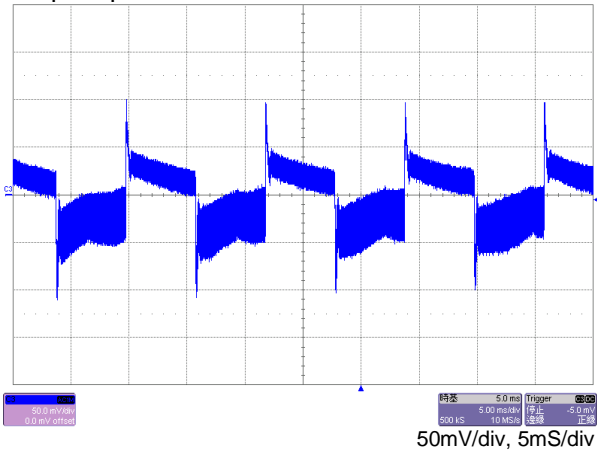

EMI: EN 55032 "B" (Conduction)



EMI: FCC "B" (Conduction)

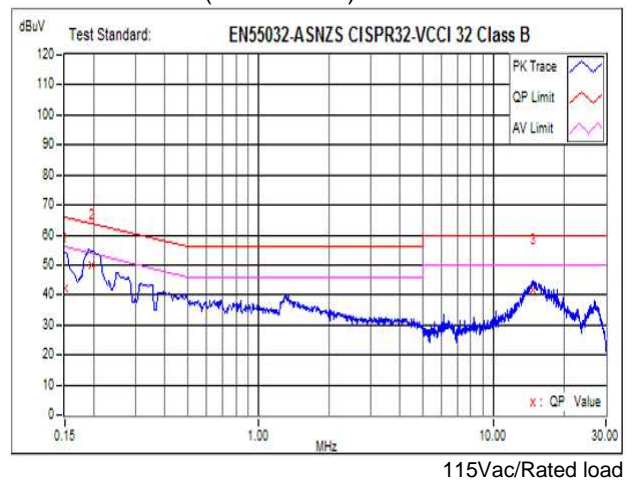

EMI: EN 55032 "B" (Radiation)

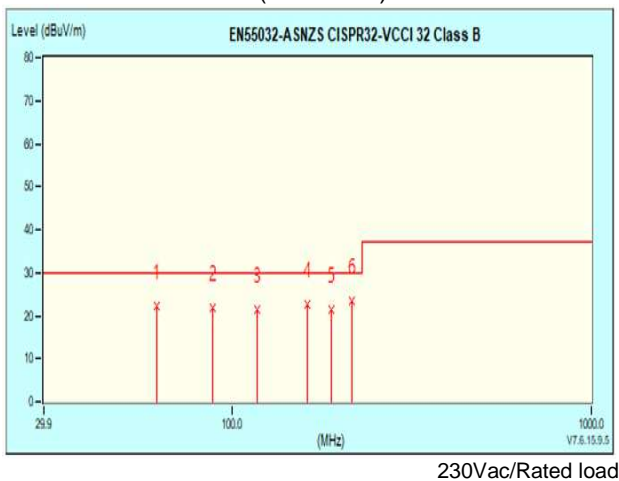

EMI: FCC "B" (Radiation)

